

VERSATURN 3.0

modulo cablato integrato a scomparsa girevole |
built-in power/data retractable swivelling system

SCHEDA TECNICA | DATA SHEET

ED.14_21.04.2026

VERSATURN 3.0

modulo cablato integrato a scomparsa girevole |
built-in power/data retractable swivelling system

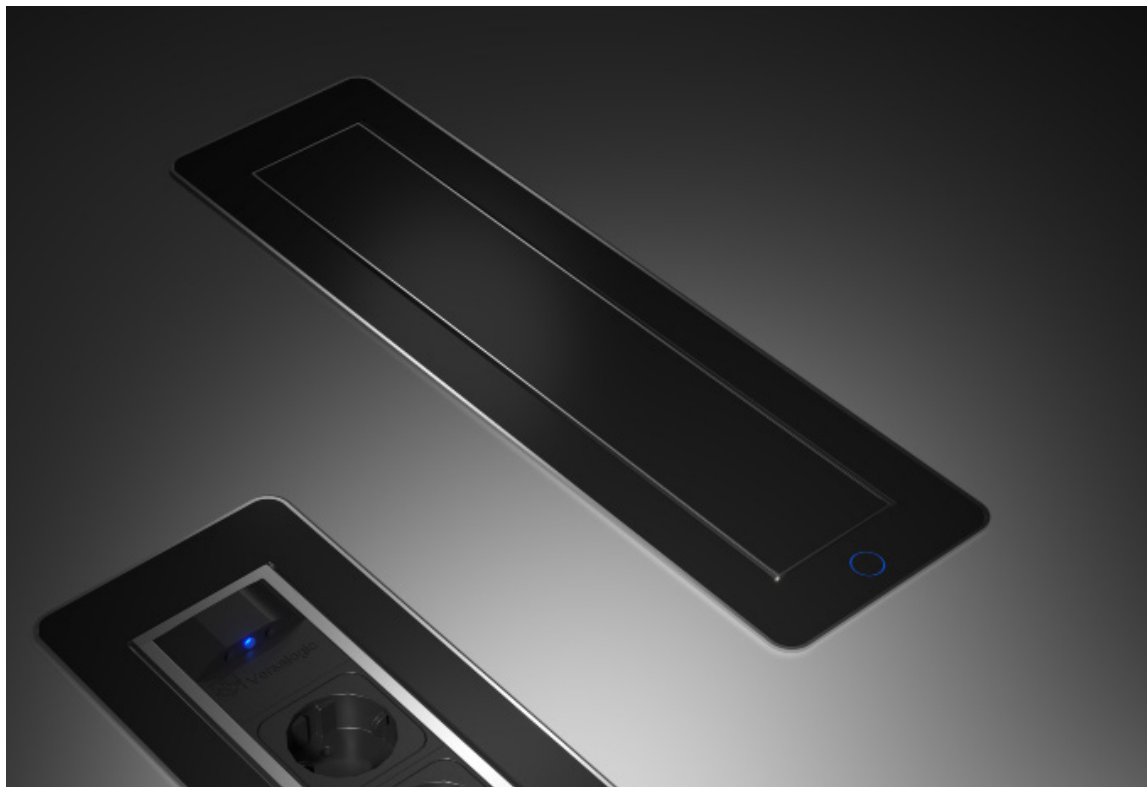

DATI COMMERCIALI | COMMERCIAL DATA

Codice prodotto Product code	060.24	Codice famiglia di prodotto - Valido per tutte le configurazioni Family product code - Valid for all configurations
---------------------------------	---------------------	--

DATI TECNICI | TECHNICAL DATA

GENERALE | GENERAL

Tensione nominale Rated voltage	110 - 250 V ac, 50 Hz
Corrente nominale Rated current	10 - 16A
Grado di protezione Degree of protection	IP20
Ambiente di utilizzo Operating environment	Interno Indoor

MATERIALI | MATERIALS

Profilo e cornice Profile and frame	Alluminio Aluminium
Componenti assemblaggio Rated current	Tecnopolimero autoestinguente Flame retardant polymer
Prese elettriche Electric Sockets	Tecnopolimero autoestinguente Flame retardant polymer

PRESE ELETTRICHE | ELECTRIC SOCKETS

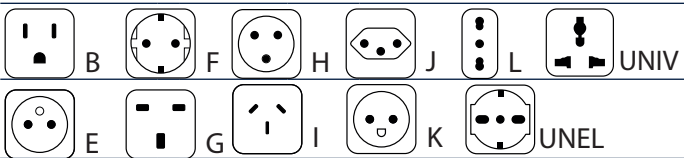
	B - E - F - G - H - I - J - K - L - Univ, Unel, 2P+T, con otturatori (protezione bimbi) B - E - F - G - H - I - J - K - L - Univ Unel, 2P+T, with shutters (child protection)		
			
Tipo Type			
	220 - 250 V ac, 50 Hz	Presa tipo Socket type	E - F - G - H - I - J - K - L - UNEL - UNIV
Voltaggio Rated voltage	110 - 125 V ac, 60 Hz	Presa tipo Socket type	B - UNIV
	16 A	Presa tipo Socket type	E - F - H - K - L - UNEL
	15 A	Presa tipo Socket type	B
	13 A	Presa tipo Socket type	G
Corrente Rated current	10 A	Presa tipo Socket type	I - J - UNIV
	3400W	Presa tipo Socket type	E - F - H - K - L - UNEL
	2800W	Presa tipo Socket type	G
	2200W	Presa tipo Socket type	I - J - UNIV
Carico massimo complessivo Max.load power	1200W	Presa tipo Socket type	B



PORTE USB DA RICARICA | USB CHARGING PORT

Ingresso Input	100 - 250 Vac 50/60 Hz		
	USB A+A	5V, 2.1A, P.Max. 10,5W condivisa tra le porte USB-A shared between USB-A ports	
	USB A+C	USB C: 5V 3A, 15W; 9V 3A, 27W; 12V 2.5A max 30W USB A: 5V 3A, 15W; 9V 3A, 27W; 12V 2.5A max 30W USB A+ USB C: 5V 3A (1.5+1.5) P.Max. 15W	
Uscita Output	USB C + C	USB C: 5V 3A, 9V 3A, 12V 3A, 15V 3A, 20V 2.35A max 47W USB C + USB C: 27W + 20W, max 47W	
Compatibilità Compatibility	Tutti smartphone, tablet e altri dispositivi ricaricabili (fotocamere, auricolari, ecc.) All smartphones, tablets and other USB chargeable devices (cameras, headset etc.)		

CONNETTORI DATI-VOCE | DATA-VOICE CONNECTORS

LAN/Ethernet	RJ45 CAT.6 UTP RJ45 CAT.6 UTP
USB	USB 2.0 USB 2.0
Video - Audio	HDMI Display Port

FINITURE | FINISHES

	Acciaio inox spazzolato Brushed stainless steel
	Vetro bianco White glass
	Vetro nero Black glass

CERTIFICAZIONI | APPROVALS



NOTE | NOTES

- Personalizzabile per tipo di prese e connettori data
- Disponibili a richiesta altre finiture
- Uso solo in ambienti interni

ATTENZIONE!!!

- Questo apparecchio deve essere collegato a terra
- L'apparecchio deve essere collegato ad una presa principale correttamente installata e provvista di collegamento a terra in accordo alle norme vigenti.
- Se il prodotto viene montato in zone a rischio di contatto con l'acqua, bisogna applicare del silicone o sigillanti similari sul piano dove appoggia la cornice.

- It can be customized according to the type of sockets and data connectors
- Indoor use only
- Other finishes available upon request

WARNING!!!

- This appliance must be earthed
- This appliance must be connected to a main socket correctly installed and provided with ground connection in accordance with current norms.
- If the product is mounted in areas at risk of contact with water, it is necessary to apply silicone or similar sealants on the panel where the frame stands.



RAEE - Rifiuti derivanti da Apparecchiature Elettriche ed Elettroniche. Questi prodotti devono essere riciclati in modo adeguato e non devono essere gettati fra i rifiuti domestici o nei rifiuti municipali indifferenziati.

WEEE - Waste of electric and electronic equipment. These products must be recycled properly and should not be disposed as household waste. Disposal in general household waste is prohibited.

Tutte le dimensioni indicate sono nominali. I disegni e le immagini sono solo a scopo illustrativo. I dettagli del prodotto e le dimensioni sono soggetti a modifiche senza preavviso.

All dimensions quoted are nominal only. Drawings and images are for illustrative purposes only. All product dimensions and specifications are subject to change without notice.

DIMENSIONI (mm) | DIMENSIONS (mm)

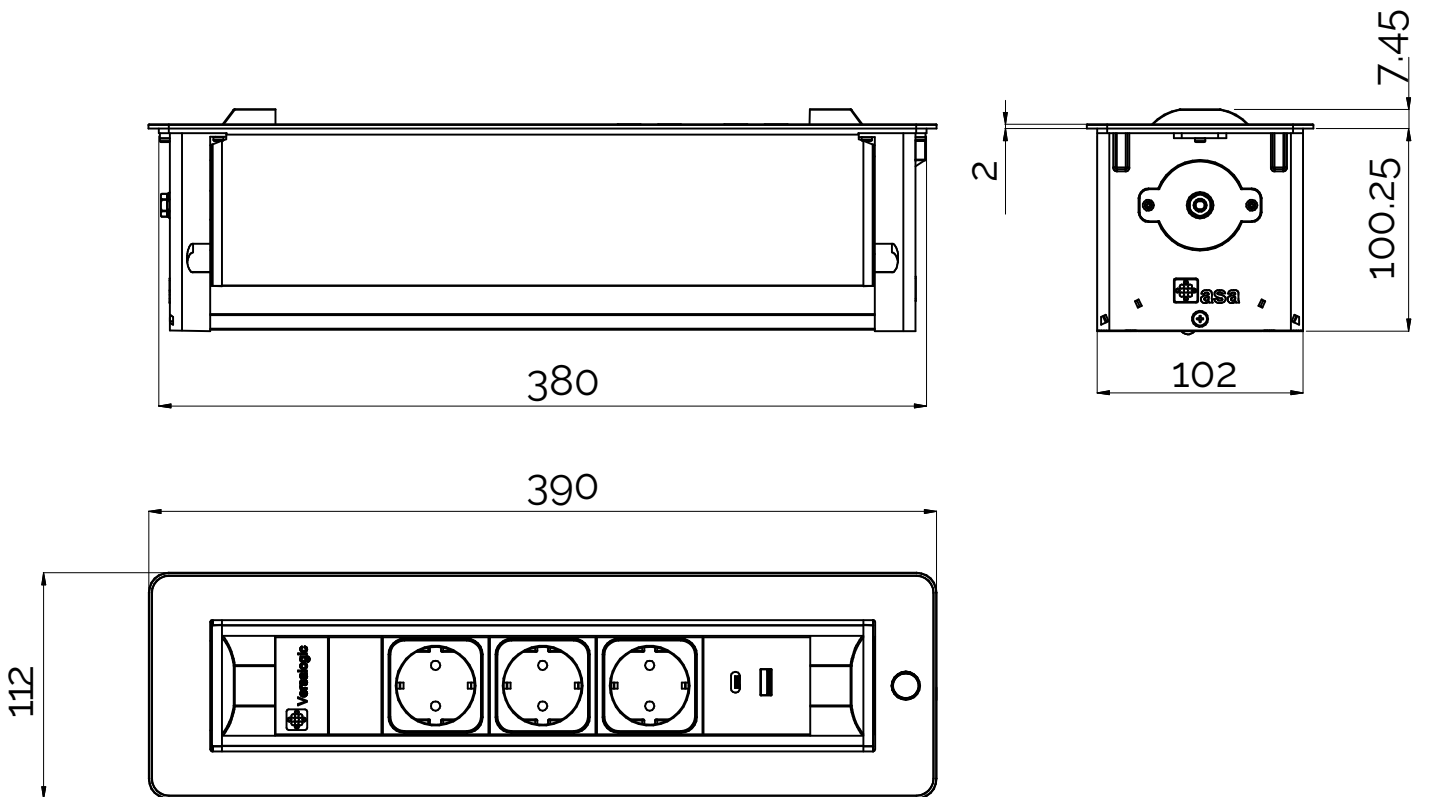

DIMENSIONI DI MONTAGGIO (mm) | CUT OUT DIMENSIONS (mm)





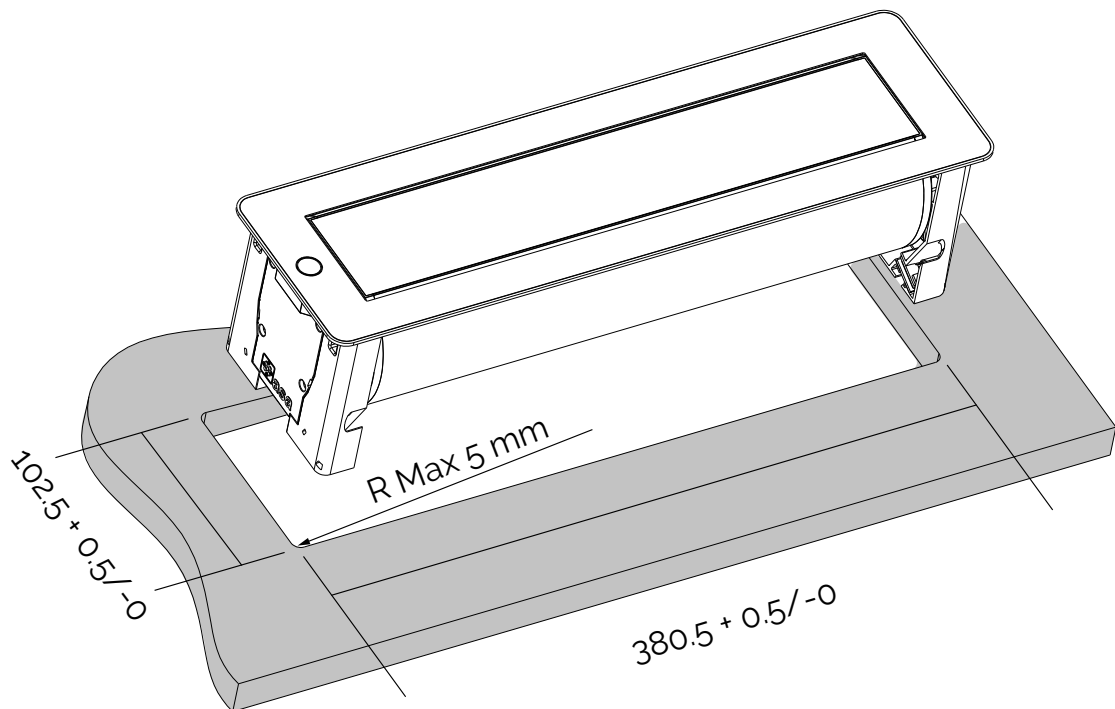





Spessore piano
Panel thickness

min 10 mm / Max 55 mm
min 10 mm / Max 55 mm





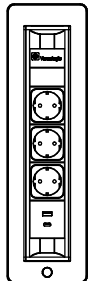
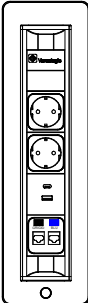
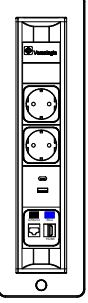









Asa Plastici srl
via Buonarroti, 58/60
20090 | Trezzano S/N (MI) | Italy
Tel/Phone +39 02 4455894 | Fax +39 02 4450107
web@asaplastici.it
asaplastici.com

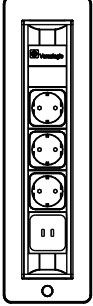
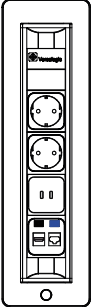

VERSATURN 3.0							
PRESA SOCKET		 	 	 	 		
		U (UNEL)	F (SCHUKO)	E (FRENCH)	G (UK)		
Cavo 2000 mm con spina separata 2000 mm cable with separated plug		3 FRUTTI POWER + 1 USB 5V (2 PORTE A+C) 3 POWER SOCKETS + 1 USB 5V (2 PORTS A+C)					L = 390 mm
CODICE CODE	vetro bianco white glass	060.24U.00031	060.24F.00032	060.24E.00028	060.24G.00020		
	PREZZO PRICE						
	vetro nero black glass	060.24U.00032	060.24F.00031	060.24E.00027	060.24G.00021		
	PREZZO PRICE						
	acciaio spazzolato stainless steel	060.24U.00033	060.24F.00033	060.24E.00029	060.24G.00019		
PREZZO PRICE							
Cavo 2000 mm con spina separata 2000 mm cable with separated plug		2 FRUTTI POWER + 2 RJ45 + 1 USB 5V (2 PORTE A+C) 2 POWER SOCKETS + 2 RJ45 + 1 USB 5V (2 PORTS A+C)					L = 390 mm
CODICE CODE	vetro bianco white glass	060.24U.00034	060.24F.00047	060.24E.00030	060.24G.00022		
	PREZZO PRICE						
	vetro nero black glass	060.24U.00035	060.24F.00048	060.24E.00031	060.24G.00023		
	PREZZO PRICE						
	acciaio spazzolato stainless steel	060.24U.00036	060.24F.00049	060.24E.00032	060.24G.00024		
PREZZO PRICE							
Cavo 2000 mm con spina separata 2000 mm cable with separated plug		2 FRUTTI POWER + 1 RJ45 CAT. 6 + 1 USB 5V (2 PORTE A+C) + 1HDMI 2 POWER SOCKETS + 1 RJ45 CAT. 6 + 1 USB 5V (2 PORTS A+C) + 1HDMI					L = 390 mm
CODICE CODE	vetro bianco white glass	060.24U.00037	060.24F.00050	060.24E.00033	060.24G.00025		
	PREZZO PRICE						
	vetro nero black glass	060.24U.00038	060.24F.00051	060.24E.00034	060.24G.00026		
	PREZZO PRICE						
	acciaio spazzolato stainless steel	060.24U.00039	060.24F.00052	060.24E.00035	060.24G.00027		
PREZZO PRICE							
NOTE NOTES							
DIM. L x H x W 560 x 150 x 210 mm			PESO WEIGHT 3,0 kg	MOQ 1 PZ / PCS	PEZZI PER SCATOLA PCS PER BOX 1	CODICE DOGANALE CUSTOM CODE 85366990	
CAVI INCLUSI CABLES INCLUDED		<input checked="" type="checkbox"/> <input type="checkbox"/>	CAVO ALIMENTAZIONE CON SPINA SEPARATA POWER CABLE FREE END PLUS SEPARATE PLUG				

VERSATURN 3.0

VERSATURN 3.0							
PRESA SOCKET		 	 	 	 		
		U (UNEL)	F (SCHUKO)	E (FRENCH)	G (UK)		
Cavo 2000 mm con spina separata 2000 mm cable with separated plug		3 FRUTTI POWER + 1 USB 5V (2 PORTE C+C) 47W 3 POWER SOCKETS + 1 USB 5V (2 PORTS C+C) 47W					L = 390 mm
CODICE CODE	Vetro bianco white glass	060.24U.00070	060.24F.00070	060.24E.00070	060.24G.00070		
	PREZZO PRICE						
	Vetro nero black glass	060.24U.00071	060.24F.00071	060.24E.00071	060.24G.00071		
	PREZZO PRICE						
	Acciaio spazzolato Brushed steel	060.24U.00072	060.24F.00072	060.24E.00072	060.24G.00072		
	PREZZO PRICE						
Cavo 2000 mm con spina separata 2000 mm cable with separated plug		2 FRUTTI POWER + 1 USB 5V (2 PORTE C+C) 47W + 1 RJ45 CAT. 6 + 1HDMI 2 POWER SOCKETS + 1 USB 5V (2 PORTS C+C) 47W + 1 RJ45 CAT. 6 +1HDMI					L = 390 mm
CODICE CODE	Vetro bianco white glass	060.24U.00073	060.24F.00073	060.24E.00073	060.24G.00073		
	PREZZO PRICE						
	Vetro nero black glass	060.24U.00074	060.24F.00074	060.24E.00074	060.24G.00074		
	PREZZO PRICE						
	Acciaio spazzolato Brushed steel	060.24U.00075	060.24F.00075	060.24E.00075	060.24G.00075		
	PREZZO PRICE						
CAVO ALIMENTAZIONE INCLUSO - 2 metri POWER CABLE INCLUDED - 2 meters							
NOTE NOTES							
DIM. L x H x W 560 x 150 x 210 mm		PESO WEIGHT 3,0 kg	MOQ 1 PZ / PCS	PEZZI PER SCATOLA PCS PER BOX 1	CODICE DOGANALE CUSTOM CODE 85366990		
CAVI INCLUSI CABLES INCLUDED	 	CAVO ALIMENTAZIONE CON SPINA SEPARATA POWER CABLE FREE END PLUS SEPARATE PLUG					